

Decorative Lighting



features: decorative luminaire with future-oriented design for post-top mounting | innovative lighting technology | Mirrortec® secondary glare free reflector system | highly efficient lighting technology for large luminaire spacing with uniform illuminance | symmetrical or asymmetrical light distribution | complete aluminium made spigot, projector and reflector cover | luminaires available in any customised colour | for tubular metal-halide lamps in ceramic and quartz technology

application: particularly suitable for glare-free illumination of shopping streets, pedestrian precincts, representative squares, parks and other landscapes | ideal for the refurbishment of old luminaires due to compatible 76 mm spigot diameter | recommended mounting height up to 4-6 meters

design: housing cover formed of aluminium sheet | rods made of stainless steel | spigot and projector made of cast aluminium | projector based on Siteco R1 MINI technology | removable built-in high performance control gear with thermal cut-out facilities | high polished specular reflector | surface powder coated in Siteco metallic grey | tempered flat glass enclosure | operation by conventional control gear with integrated thermal fuse | IP65: against dust and moisture | integrated pressure equalisation port for condensation avoidance



Order No.	Description	Lamps	Weight
5NX 314 E-1MA 08	post top luminaire GALAXSiE ALU with Mirrortec® technology, IP65, asymmetrical light distribution, built-in control gear, p.f. corrected, Siteco metallic grey finish *	1 x 70W HIT-CE	12.5 kg
5NX 314 E-1PA 08	post top luminaire GALAXSiE ALU with Mirrortec® technology, IP65, asymmetrical light distribution, built-in control gear, p.f. corrected, Siteco metallic grey finish *	1 x 150W HIT-CE	13.5 kg
5NX 314 E-1MS 08	post top luminaire GALAXSiE ALU with Mirrortec® technology, IP65, symmetrical light distribution, built-in control gear, p.f. corrected, Siteco metallic grey finish *	1 x 70W HIT-CE	12.5 kg
5NX 314 E-1PS 08	post top luminaire GALAXSiE ALU with Mirrortec® technology, IP65, symmetrical light distribution, built-in control gear, p.f. corrected, Siteco metallic grey finish *	1 x 150W HIT-CE	13.5 kg

* other RAL colours on request

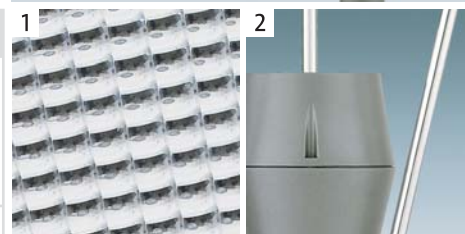

1. Siteco Mirrortec® technology
2. high performance projector

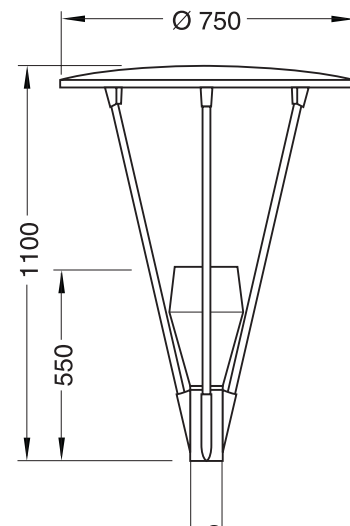

light distribution curve:

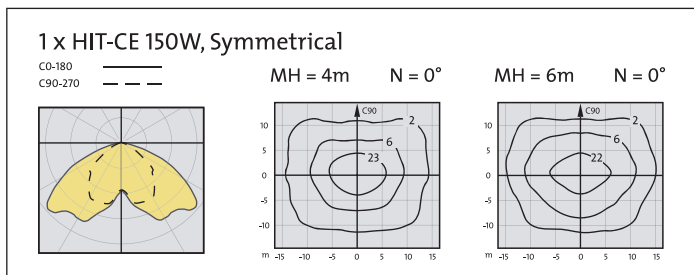
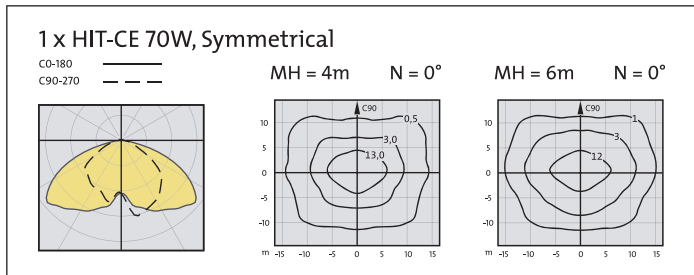
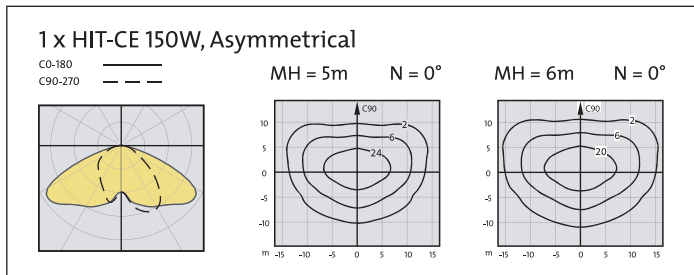
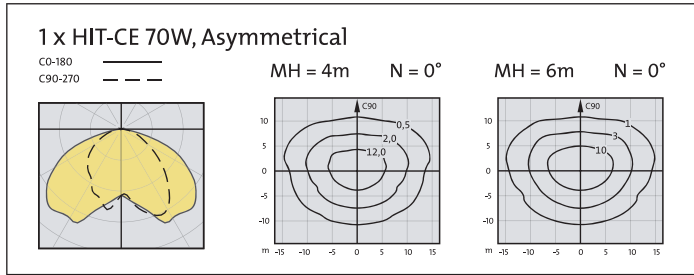

technical data: rated voltage: 230/240V, 50Hz (other voltage available on request)

circuit arrangement: p.f. corrected, all electrical components with thermal protection fuse

ambient temperature: -20°C...+45°C

protection class: IP 65

windage area: 0.16m²

installation: the luminaires delivered by three components (reflector cover, rods, post top with attached projector) can be assembled on ground before fixing at the pole | post top and the reflector cover will be connected by three rods | the rods will be secured by provided screws | it is recommended to use silicon glue for sealing the rod attachment | the projector is provided with a 3.5 meter connecting cable | opening of the projector front cover for lamp insert by four screws

service and maintenance: under normal environmental conditions the projector and the reflector do not need any service and maintenance | easy access for lamp replacement and trouble shooting by removable front cover and a plugged-in control gear

logistic: the luminaires are delivered in three parts (reflector cover, rods, post top with attached projector) | the components are individually packed in three carton boxes | for deliveries in larger quantity the components may be packed in pairs or larger volumes for economical reasons | the cartons may be loaded individually or stacked on pallets | the capacity of the containers is based on pallet loading

	carton
620 x 370 x 300 mm 760 x 760 x 330 mm (l x w x h) 930 x 70 x 30 mm	

	weight
16.0 kg (70W) 17.0 kg (150W)	

	pallet
5 units, 1200 x 800 x 1240 mm (l x w x h)	

	container
20' : 11 pallets, 55 units 40' : 22 pallets, 120 units	