



**features:** axially symmetrical compact projector | for standard lamps application | for remote gear operation of tubular metal-halide lamps in ceramic and quartz technology | die cast aluminium housing | wide range of accessories

**application:** for architectural spot lighting indoors and outdoors | typical uses for terraces, gardens, sign boards and building facades | architectural spot lighting for extreme distances with metal-halide lamps

**design:** housing made of die-cast aluminium | surface powder coated in Siteco metallic grey | mounting stirrup made of steel or aluminium, powder coated | tempered flat glass enclosure | integrated pressure equalisation port for condensation avoidance | availability in any required colour for projects



Order No.	Description	Lamps	Weight
5NX 723 0-INF 08	R1 MINI ECO, axially symmetrical projector, E27 lamp holder for mains voltage incandescent lamps, Siteco metallic grey finish*	1 x 50-120W PAR 38	3.1 kg
5NX 723 7-1NH 08	R1 MINI ECO, axially symmetrical projector for low voltage halogen reflector lamps, G53 base, built in electronic transformer, Siteco metallic grey finish*	1 x 35-75W reflector lamp D111	3.2 kg
5NX 723 0-10B 08	R1 MINI ECO, axially symmetrical compact projector for remote gear operation, narrow beam, built-in ignitor, Siteco metallic grey finish,* control gear not included	1 x 35-150W HIT-CRI/CE	3.1 kg
5NX 723 0-10S 08	R1 MINI ECO, axially symmetrical compact projector for remote gear operation, wide beam, built-in ignitor, Siteco metallic grey finish,* control gear not included	1 x 35-150W HIT-CRI/CE	3.1 kg

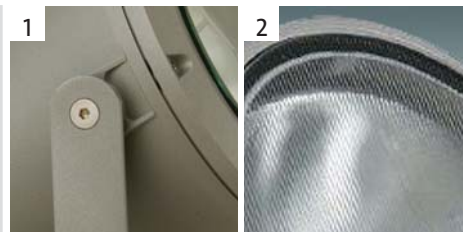

1. prominent design with high-grade finish  
2. projector with filter ring accessory

\* other RAL colours on request e.g. -05 = white (RAL 9010), -01 = black (RAL 9005)

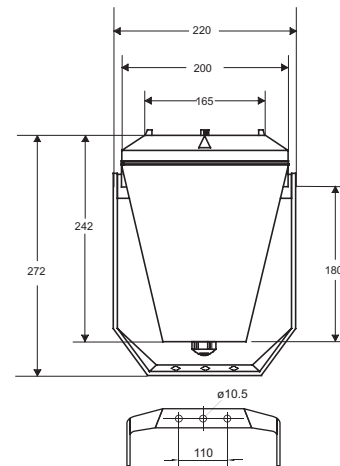

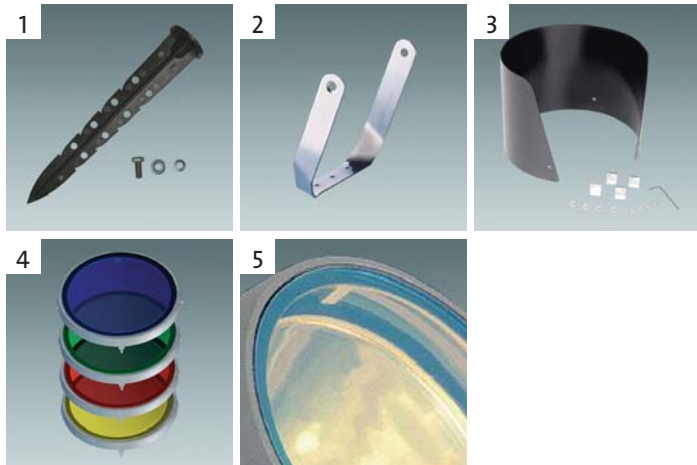

1. ground stake
2. stainless steel bracket, tilted
3. shield
4. colour filters
5. dichroic filter

### accessories:

Order No.	Description	Size	Weight
5NX 721 0-0ES	ground stake, die-cast aluminium, black powder coated, complete with V2A M8 screw	270 mm long	0.3kg
5NX 724 0-0EB00	stainless steel bracket, V4A uncoated, tilted version	215 x 220 x 40 mm	0.6 kg
5NX 724 0-0XB01	shield, for R1 MINI, made of aluminium, matt black powder coated, complete with mounting accessories	D 177 x 130 mm	0.2 kg
5NX 724 0-0XG02 08	green colour filter, complete with mounting ring in Siteco metallic grey finish*	D 164 x 25 mm	0.3 kg
5NX 724 0-0XG03 08	red colour filter, complete with mounting ring in Siteco metallic grey finish*	D 164 x 25 mm	0.3 kg
5NX 724 0-0XG04 08	blue colour filter, complete with mounting ring in Siteco metallic grey finish*	D 164 x 25 mm	0.3 kg
5NX 724 0-0XG42 08	yellow colour filter, complete with mounting ring in Siteco metallic grey finish*	D 164 x 25 mm	0.3 kg
5NX 724 0-0XGS1 08	linear spread filter, complete with mounting ring in Siteco metallic grey finish*	D 164 x 25 mm	0.3 kg
5NX 724 0-0XGS2 08	linear / vertical spread filter, complete with mounting ring in Siteco metallic grey finish*	D 164 x 25 mm	0.3 kg
5NX 724 0-0XGS3 08	diffusing spread filter, complete with mounting ring in Siteco metallic grey finish*	D 164 x 25 mm	0.3 kg
5NX 724 0-0XGD2 08	green dichroic filter, complete with mounting ring in Siteco metallic grey finish*	D 164 x 25 mm	0.3 kg
5NX 724 0-0XGD3 08	red dichroic filter, complete with mounting ring in Siteco metallic grey finish*	D 164 x 25 mm	0.3 kg
5NX 724 0-0XGD4 08	blue dichroic filter, complete with mounting ring in Siteco metallic grey finish*	D 164 x 25 mm	0.3 kg
5NX 724 0-0XGD5 08	yellow dichroic filter, complete with mounting ring in Siteco metallic grey finish*	D 164 x 25 mm	0.3 kg
5NX 724 0-0XGD6 08	orange dichroic filter, complete with mounting ring in Siteco metallic grey finish*	D 164 x 25 mm	0.3 kg

\* other RAL colours on request, e.g. -05 = white (RAL 9010); -01 = black (RAL 9005)

**technical data:**

- rated voltage: 230/240V, 50Hz (other voltage available on request)
- ambient temperature: -20°C...+35°C
- protection class: IP 65
- windage area: 0.03m<sup>2</sup> (front), 0.04m<sup>2</sup> (side)

**installation:**

mounting base to be fixed by one (central) or two screws (max. M10) | cable entry by M20 cable gland (for cables of 8-16 mm in diameter) | opening of the front cover by four screws | stepless tilting through 360° on the mounting brackets | axially rotating through 360° when fixed by one screw only

**service and maintenance:**

easy access for lamp replacement and trouble shooting by removable front cover, which is secured by four screws

**remote gears:**

for individual remote control gear operation (metal halide lamps only), corrosion resistant control gear units are available | available for 35W...150W | protection rate IP65 | refer to Siteco's list of accessories



**logistic:**

the luminaires are individually packed in carton boxes | the cartons may be loaded individually or stacked on pallets | the capacity of the containers is based on pallet loading

	<b>carton</b>
220 x 220 x 305 mm (l x w x h)	

	<b>weight</b>
4.0 - 5.0 kg	

	<b>pallet</b>
60 units, 1200 x 800 x 1400 mm (l x w x h)	

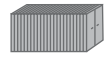
	<b>container</b>
20' : 11 pallets, 660 units 40' : 22 pallets, 1320 units	